



P-Channel Electrical Characteristics ( $T_J=25\text{ }^\circ\text{C}$ , unless otherwise noted)

Symbol	Parameter	Conditions	Min.	Typ.	Max.	Unit
$BV_{DSS}$	Drain-Source Breakdown Voltage	$V_{GS}=0V, I_D=-250\mu A$	-60	---	---	V
$\Delta BV_{DSS}/\Delta T_J$	$BV_{DSS}$ Temperature Coefficient	Reference to $25^\circ\text{C}$ , $I_D=-1\text{mA}$	---	-0.023	---	$V/^\circ\text{C}$
$R_{DS(ON)}$	Static Drain-Source On-Resistance <sup>2</sup>	$V_{GS}=-10V, I_D=-10A$	---	70	87	m $\Omega$
		$V_{GS}=-4.5V, I_D=-5A$	---	88	99	
$V_{GS(th)}$	Gate Threshold Voltage	$V_{GS}=V_{DS}, I_D=-250\mu A$	-1.0	-1.6	-2.5	V
$\Delta V_{GS(th)}$	$V_{GS(th)}$ Temperature Coefficient		---	4.65	---	$\text{mV}/^\circ\text{C}$
$I_{DSS}$	Drain-Source Leakage Current	$V_{DS}=-48V, V_{GS}=0V, T_J=25^\circ\text{C}$	---	---	1	$\mu\text{A}$
		$V_{DS}=-48V, V_{GS}=0V, T_J=55^\circ\text{C}$	---	---	5	
$I_{GSS}$	Gate-Source Leakage Current	$V_{GS}=\pm 20V, V_{DS}=0V$	---	---	$\pm 100$	nA
gfs	Forward Transconductance	$V_{DS}=-5V, I_D=-4A$	---	8.7	---	S
$R_g$	Gate Resistance	$V_{DS}=0V, V_{GS}=0V, f=1\text{MHz}$	---	15	---	$\Omega$
$Q_g$	Total Gate Charge (-4.5V)	$V_{DS}=-12V, V_{GS}=-4.5V, I_D=-6A$	---	11.8	---	nC
$Q_{gs}$	Gate-Source Charge		---	1.9	---	
$Q_{gd}$	Gate-Drain Charge		---	6.5	---	
$T_{d(on)}$	Turn-On Delay Time	$V_{DD}=-15V, V_{GS}=-10V, R_G=3.3\Omega, I_D=-1A$	---	8.8	---	ns
$T_r$	Rise Time		---	19.6	---	
$T_{d(off)}$	Turn-Off Delay Time		---	47.2	---	
$T_f$	Fall Time		---	9.6	---	
$C_{iss}$	Input Capacitance	$V_{DS}=-15V, V_{GS}=0V, f=1\text{MHz}$	---	1880	---	pF
$C_{oss}$	Output Capacitance		---	73	---	
$C_{rss}$	Reverse Transfer Capacitance		---	50	---	

## Diode Characteristics

Symbol	Parameter	Conditions	Min.	Typ.	Max.	Unit
$I_S$	Continuous Source Current <sup>1,5</sup>	$V_G=V_D=0V$ , Force Current	---	---	-10	A
$I_{SM}$	Pulsed Source Current <sup>2,5</sup>		---	---	-20	A
$V_{SD}$	Diode Forward Voltage <sup>2</sup>	$V_{GS}=0V, I_S=-1A, T_J=25^\circ\text{C}$	---	---	-1	V

Note :

- 1.The data tested by surface mounted on a 1 inch<sup>2</sup> FR-4 board with 2OZ copper.
- 2.The data tested by pulsed , pulse width  $\leq 300\mu\text{s}$  , duty cycle  $\leq 2\%$
- 3.The EAS data shows Max. rating . The test condition is  $V_{DD}=-25V, V_{GS}=-10V, L=0.1\text{mH}, I_{AS}=-24.4A$
- 4.The power dissipation is limited by  $150^\circ\text{C}$  junction temperature
- 5.The data is theoretically the same as  $I_D$  and  $I_{DM}$  , in real applications , should be limited by total power dissipation.

**P-Channel Typical Characteristics**

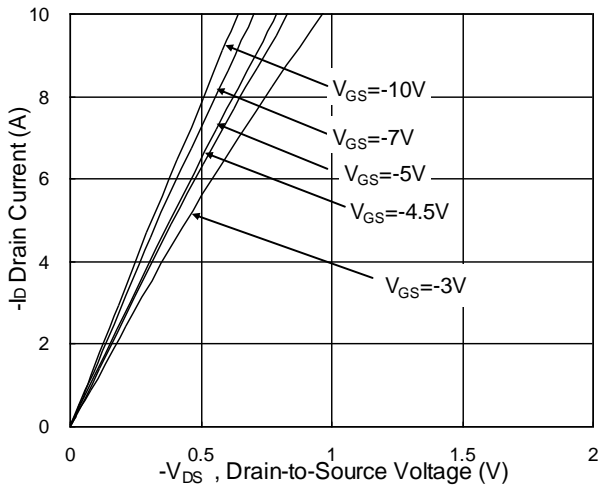

**Fig.1 Typical Output Characteristics**

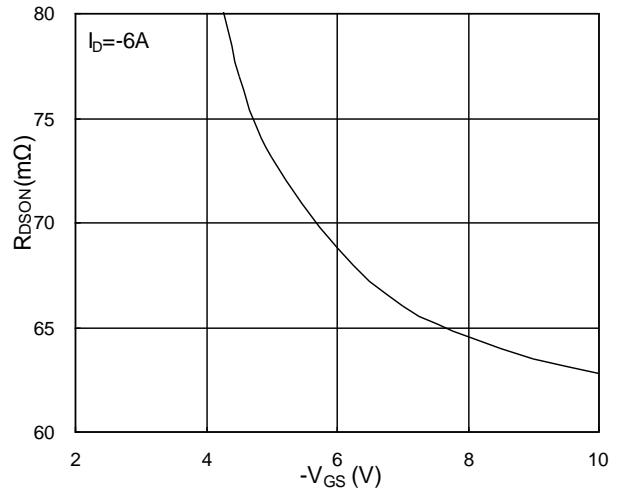

**Fig.2 On-Resistance v.s Gate-Source**

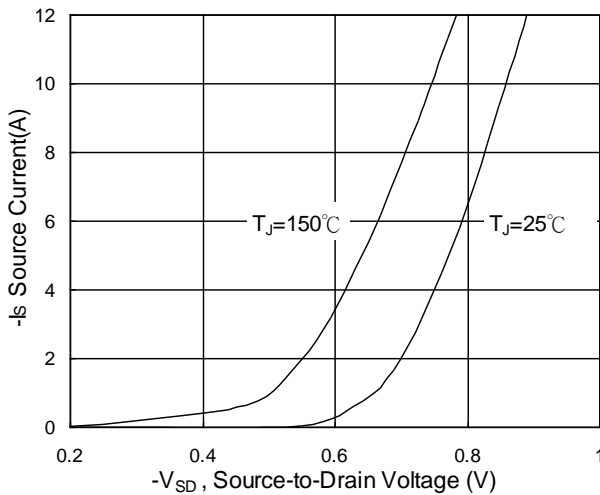

**Fig.3 Forward Characteristics of Reverse**

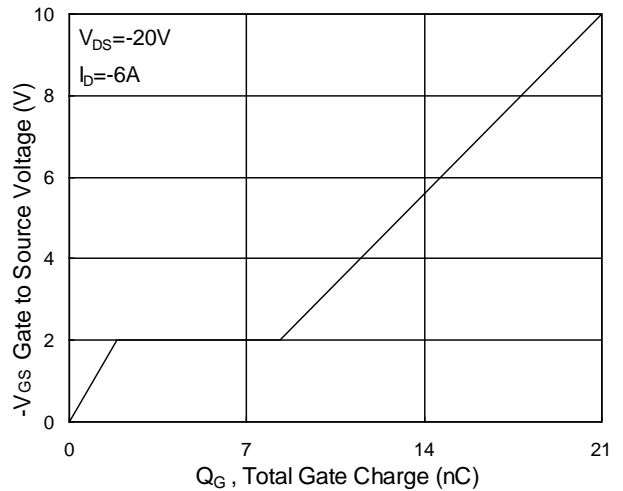

**Fig.4 Gate-Charge Characteristics**

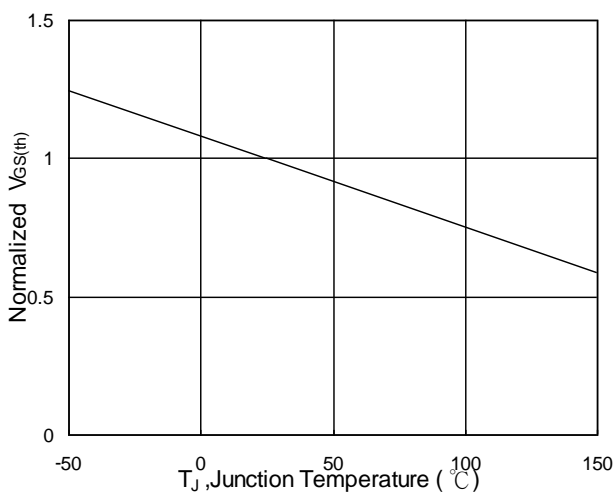

**Fig.5 Normalized V<sub>GS(th)</sub> v.s T<sub>J</sub>**

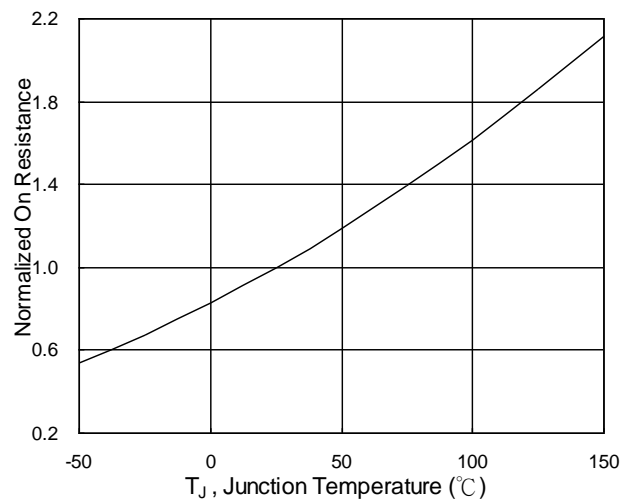

**Fig.6 Normalized R<sub>DS(on)</sub> v.s T<sub>J</sub>**

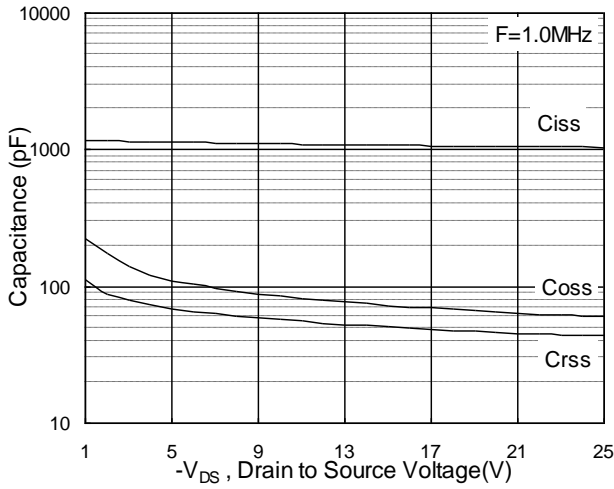

Fig.7 Capacitance

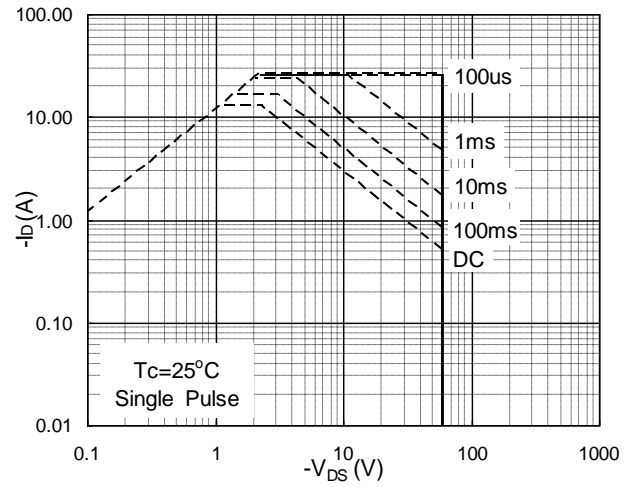

Fig.8 Safe Operating Area

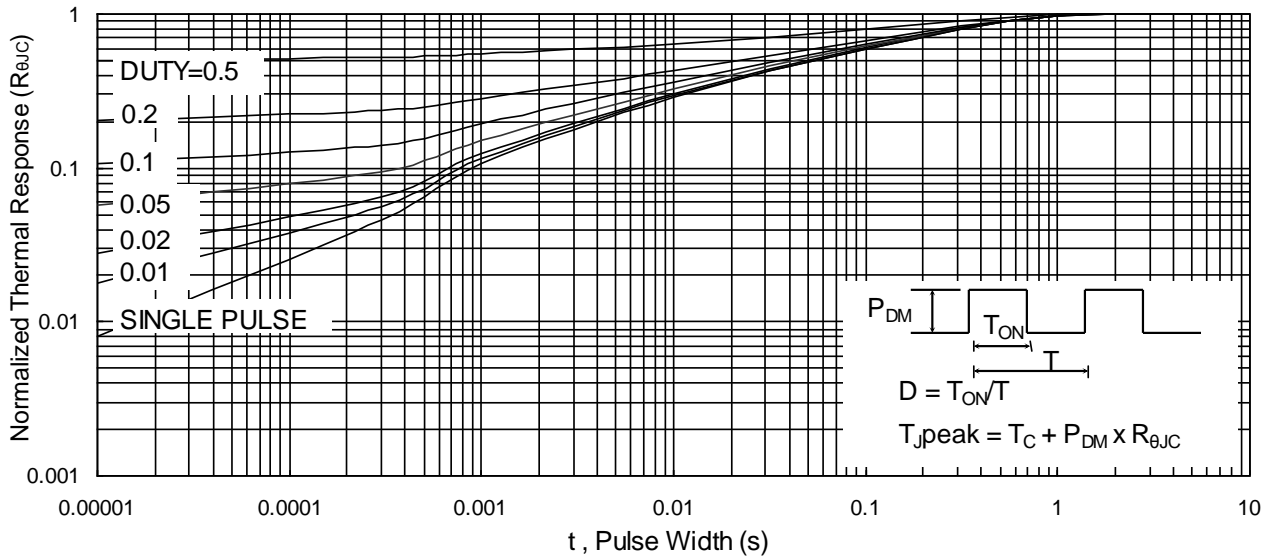

Fig.9 Normalized Maximum Transient Thermal Impedance

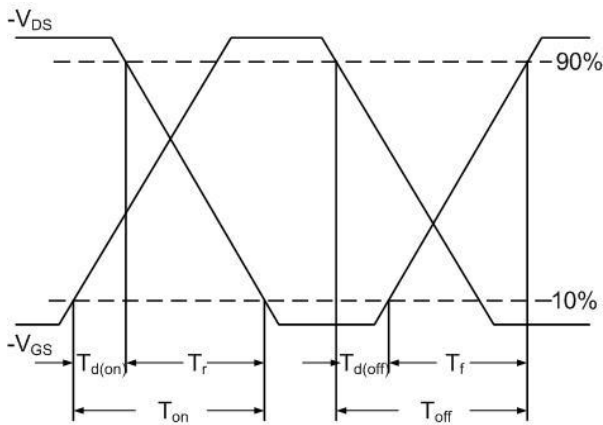

Fig.10 Switching Time Waveform

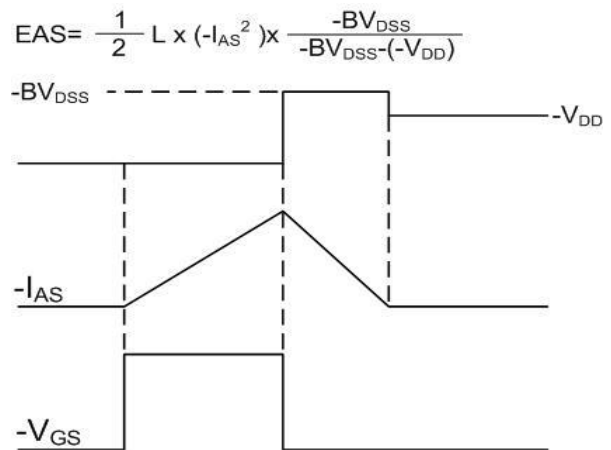
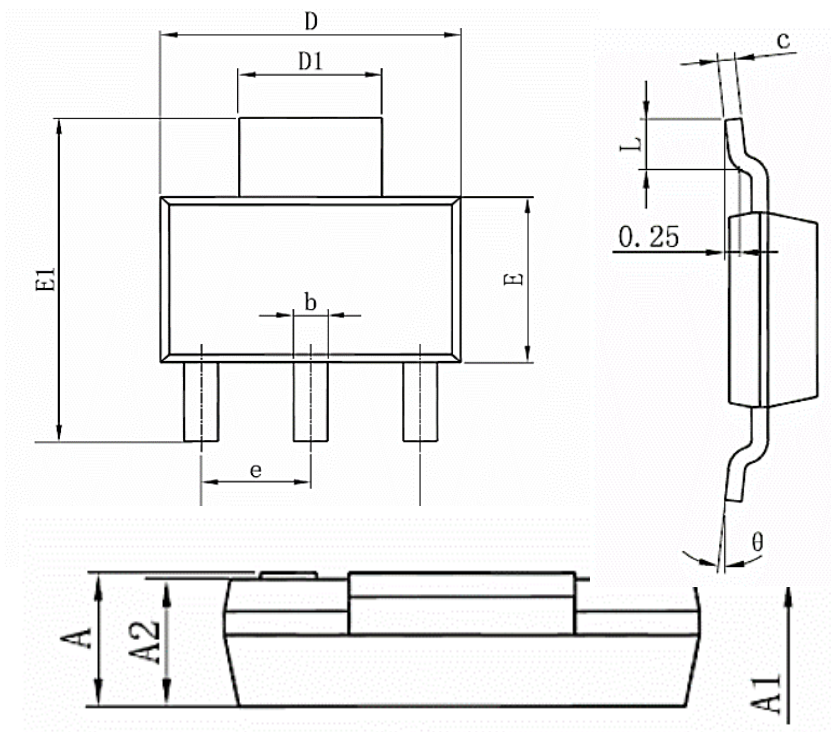

Fig.11 Unclamped Inductive Switching Waveform

## Package Mechanical Data:SOT-223-3L



Symbol	Dimensions In Millimeters		Dimensions In Inches	
	Min.	Max.	Min.	Max.
A	1.52	1.8	0.06	0.049
A1	0.000	0.100	0.000	0.004
A2	1.5	1.7	0.059	0.045
b	0.66	0.82	0.026	0.032
c	0.25	0.35	0.010	0.014
D	6.2	6.4	0.244	0.252
D1	2.9	3.1	0.114	0.122
E	3.3	3.7	0.130	0.146
E1	6.83	7.07	0.269	0.278
e	2.300(BSC)		0.037(BSC)	
e1	4.500	4.700	0.177	0.185
L	0.900	1.15	0.035	0.045
θ	0°	10°	0°	10°